



FLEXIBLE COUPLING



線性傳動元件
聯軸器

聯軸器專業製造廠

精禾科技股份有限公司

台中市西屯區福中二街10巷22號1樓

TEL : 04-23501313 傳真 : 04-23501389

電子信箱 : genho.com@msa.hinet.net

謙虛的態度、專業的服務

 **SONG
CHENG** PRECISE TECHNOLOGY CO.,LTD.,











■ 撓性聯軸器

品號 Item	材質 Material	高扭力 High Torque	低慣性 Low Inertia	零背隙 Zero Backlash	高剛性 High Rigid	絕緣性 High Insulation	抗蝕性 Erode Resistance	抗震性 Anti- seismic	偏心佳 High Eccentric	偏角佳 High Deflection	PAGE
 SGH-C	AL	●	●	●	●						16
 SGS-C	AL	●	●	●	●						17
 SGL-C	AL	●	●	●	●					●	18
 SGB-C	AL	●	●	●	●						19
 SGM-C	AL	●	●	●	●					●	20
 SGW-C	AL	●	●	●	●					●	21
 SAP	S45C	●	●	●	●			●	●		22
 SAP-C	S45C	●	●	●	●			●	●		23
 SRJ	AL	●	●		●			●			24
 SRJ-C	AL	●	●		●			●			25
 SRJS	S45C	●	●		●			●			26



聯軸器產品檢索

COUPLING GUIDE

撓性聯軸器

品號 Item	材質 Material	高扭力 High Torque	低慣性 Low Inertia	零背隙 Zero Backlash	高剛性 High Rigid	絕緣性 High Insulation	抗蝕性 Erode Resistance	抗震性 Anti-seismic	偏心佳 High Eccentric	偏角佳 High Deflection	PAGE
 SCT	AL	●	●	●						●	07
 SCTS	SUS	●	●	●	●		●				07
 SCT-C	AL	●	●	●						●	09
 SCTS-C	SUS	●	●	●	●		●				09
 SWS	AL	●	●	●						●	11
 SWSS	SUS	●	●	●	●		●			●	11
 SWS-C	AL	●	●	●						●	12
 SWSS-C	SUS	●	●	●	●		●				12
 SCPB	PLASTIC		●	●		●	●			●	13
 SMT	AL		●	●						●	14
 SMT-C	AL		●	●						●	15

■ 撓性聯軸器

品號 Item	材質 Material	高扭力 High Torque	低慣性 Low Inertia	零背隙 Zero Backlash	高剛性 High Rigid	絕緣性 High Insulation	抗蝕性 Erode Resistance	抗震性 Anti- seismic	偏心佳 High Eccentric	偏角佳 High Deflection	PAGE
 SRJS-C	S45C	●	●		●			●			26
 SOT	AL	●	●		●	●		●	●	●	27
 SOT-C	AL	●	●		●	●		●	●	●	28

■ 剛性聯軸器

品號 Item	材質 Material	高扭力 High Torque	低慣性 Low Inertia	零背隙 Zero Backlash	高剛性 High Rigid	絕緣性 High Insulation	抗蝕性 Erode Resistance	抗震性 Anti- seismic	偏心佳 High Eccentric	偏角佳 High Deflection	PAGE
 SCG	AL	●	●	●	●						29
 SCGS	SUS	●	●	●	●						29
 SCG-C	AL	●	●	●	●						30
 SCGS-C	SUS	●	●	●	●						30

聯軸器介紹 Introduction to Coupling

聯軸器是連接兩個不同機器的軸，使之供回轉，在容許範圍內的軸向、平行、角度偏差位移時仍能正常的運作、並傳遞安全轉矩的一種機械裝置。

A coupling is a mechanical device that serves to connect two different machines for rotating and for the normal operation within the permissible axial, parallel and angle deviation ranges, and transmits safe torques.



使用目的 Purposes

1. 連結二個個別製造的旋轉機器的軸(如馬達和螺桿)，在需要更換或維修時可以拆卸。
2. 增加機械的可撓性，允許軸有小幅度的偏差。
3. 聯軸器為一種安全裝置，保護機構免於撞損。
4. 調整或改善轉元件的振動特性。
5. 功率或轉矩的傳達。

1. To link the axes of two independent rotating machines (such as motor and screw), and allow the disassembly for replacement or repair.
2. To increase the flexibility of machines and allow the minor deviation of axes.
3. A coupling is a safety device to protect the machines from being damaged.
4. To adjust or improve the vibration characteristics of rotating components.
5. To realize the transmission of power or torque.

聯軸器種類 The kind of coupling

一般聯軸器可分為撓性及剛性聯軸器兩大類。

1. 撓性聯軸器 (Flexible Coupling):

當動力傳達、兩軸要配置成一直線發生困難時，或者兩軸之安裝非常簡單時，應使用可撓性聯軸器，它具有緩和衝擊、吸收平行、偏角、軸向位差、改善系統傳動動力特性的功能，因此在安裝時，即使軸發生少許之偏差，而軸承也不會有勉強之情形，在市場上應用非常廣泛。

2. 剛性聯軸器 (Rigid Coupling):

可精確的傳遞扭矩，為一無法造成偏心、偏角之元件，能使被連接的兩軸固定成為一體，因此使用上同心度必需要求非常高。

The coupling can be divided into two major categories: flexible coupling and rigid coupling.

1. Flexible Coupling:

Flexible coupling is applied when it is difficult to configure the power transmission and two axes into a straight line or when the installation of two axes is very simple. Flexible coupling has the functions of alleviating the impact, allowing the parallel, angle and axial potential differences as well as improving the transfer power characteristics of the system. That is to say, such coupling can ensure that the axes rotate smoothly even when there are minor deviations in installation. The flexible coupling is widely used.

2. Rigid Coupling:

Rigid coupling is the component that can transmit torques accurately, completely prevent the deflective angle and eccentricity as well as integrate the two axes connected into a unit; therefore, the application of rigid coupling has a high requirement for concentricity.

設計上的確認事項

Confirmations on Design

依據機械特性、系統運作來選用適合的聯軸器型式：

An appropriate coupling is selected according to mechanical properties and operation of the system:

● 扭力的大小 Torque :

聯軸器的扭力應為傳動扭力最大值的兩倍。例：若傳動扭力值為5N.m,則應選擇扭力值10N.m(型錄標示為“一般扭力”區),選擇聯軸器時,不應超過容許扭力值。材質以鋼質的扭力為佳。

The torque of a coupling must be twice the maximum of the transmission torque. For example: if the drive torque is 5N.m, you should select a torque of 10N.m (labeled "general torque" on the catalog). In selecting the coupling, it should be within the permissible torque. The steel torque is the best.

● 撓性與剛性 Flexible and rigid:

撓性聯軸器可吸收平行偏差、角度偏差、軸向偏差；剛性聯軸器則無此特性，因此兩軸的精準度必需非常高，否則易造成軸心斷裂。

Flexible coupling can absorb parallel deviation, angle deviation and axial deviation. Rigid coupling does not have this function; therefore, in using rigid coupling, the accuracies of the two axes must be very high. Otherwise, fracture of the axes can easily happen.

● 使用的環境 Application environment :

需慎選聯軸器之材質是否堪負荷高低溫、耐酸鹼、空間大小...等。

It needs to take into account whether the selected coupling is suitable for the environment of high and low temperature, acid-base, space size, etc.

● 有無背隙 With/without backlash :

中間有橡膠之緩衝材均有背隙的存在，要判斷機構是否可承受背隙。

Whenever the rubber cushion is available in the middle, the coupling experiences backlash; whether the body can withstand the backlash needs to be determined.

● 絕緣性 Insulation :

需選擇工程塑膠類聯軸器才可絕緣。

Only engineering plastic couplings have insulation function.

● 抗震性 Shock resistance :

聯軸器中間有工程塑膠、橡膠之材質較易吸收震動；中間為金屬彈片夾之；剛性聯軸器則毫無抗震性。

When the coupling contains engineering plastic or rubber materials in the middle, its shock resistance is better, followed by coupling with metal sheets, and then rigid coupling without shock resistance function.

● 可承受選大轉速 High speed resistance :

設計上請參考規格表中的容許值，否則易影響聯軸器壽命。

In design, please refer to the permissible values in the specifications or the lifespan of the coupling will be shortened.

● 孔徑範圍是否適用 Applicable aperture range :

請選擇型錄內所載的容許孔徑為主，過大、過小或兩端差距太大，可能損及軸心、導致斷裂。

Please select couplings within the permissible apertures described in the catalog. Couplings with too large or too small aperture or too big a gap between both ends may damage the axes or lead to fracture.

聯軸器的異常情形

Abnormalities of coupling

聯軸器是一種不需保養的構件，平常只需注意聯軸器是否有磨損或疲勞的徵兆、螺絲是否鬆動、異常雜音及振動搖擺的情形發生，若有異常，請立刻停止運轉，確認中心是否有校正準確、慣性是否過大、螺絲有無鎖緊。為了提昇機構的壽命，在更換下一個聯軸器之前，先了解其造成損壞的原因，再來選擇更適合的聯軸器。

The coupling is a maintenance-free component but attention needs to be paid to the following : whether the coupling has signs of wear or fatigue ; whether the screw is loose, or has abnormal noise and vibration. In case of please shut down the machines

to confirm whether the center is calibrated, whether the inertia is too large and whether the screws are locked. To extend the lifespan of the coupling, please find the reason for the damage before replacing with new coupling, and then select a more suitable coupling.

聯軸器的固定方式

Fixing of Coupling

●止付螺絲固定式 Fixed by set screw :

係以四根固定止付螺絲以 90° 或 120° 角固定於軸心上，體積小、安裝容易、成本低，但因機械長時間的轉動、衝擊而使螺絲鬆脫、軸心表面容易有螺絲壓痕、拆卸困難。此固定方式成本低。

The method is to fix the coupling with four set screws to the axes at 90° or 120° , characterized by small size, easy to install and low cost; however, the long-term rotation and impact of the machines may loosen the screws, leave screw marks on the axis surface and lead to difficult disassembly. Low-cost is the advantage of this method.

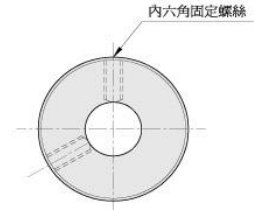

圖一 固定螺絲式 Set screw type

●夾緊式 Fixed by clamping :

聯軸器雙邊各有切開之溝槽形成彈性作用，並在夾軸兩邊插入二或四支有頭內六角螺絲，使溝槽縮緊住軸心；拆卸容易、不易損傷軸心，有較佳的穩定、保持力。

Both sides of the coupling have cut grooves that are flexible; two or four socket head screws are inserted into two sides of the clamp to allow the groove to tighten the axes. The method has the advantages of easy disassembly, protection of axis, and better stability and maintaining.

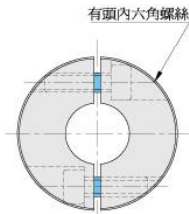

圖二 夾緊式 clamp type

●鍵槽型 Keyway :

止付螺絲固定式及夾緊式皆可加工鍵槽，利用鍵的嵌合，防止滑動，適合高扭矩之機構。

Both the method of fixation by set screw and fixation by clamping allow the processing of keyways. The inosculating of keyways can prevent sliding, which is suitable for machines with high torques.

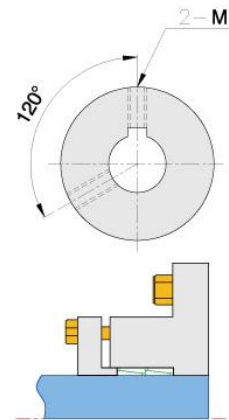

●免鍵式壓環固定式 Fixed by free-button compression ring :

利用壓環逼緊軸心，以致收合夾緊。

The compression ring is used to tighten the axes in order to clamp the axes.

聯軸器偏差調整

Adjustment of Deviation

聯軸器容許微量偏差，偏差過大會造成聯軸器及軸心斷裂，因此在機械組裝時，請注意精度平衡校正的動作，以利安裝、延長使用壽命，以提高機械效率。

The coupling allows minor deviation; large deviation may cause breakdown of the coupling and the axes; therefore, during assembly, more attention should be paid to precision flat correction, which facilitates the installation and lifespan, and increases the utilization ratio of machines.

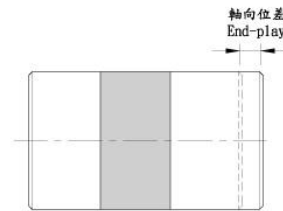
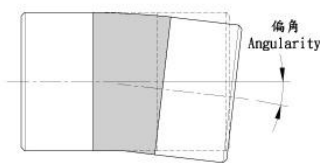
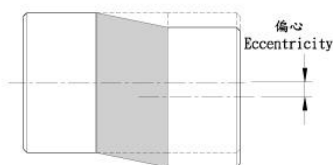

SGH-C 鋼片型 / 夾緊式 / 短型撓性聯軸器

DISK / CLAMP TYPE / SHORTER OF FLEXIBLE COUPLING



材質 | Material

鋁合金 Aluminum alloy
緩衝材: 不銹鋼彈片
Buffer material: SUS disk

表面處理 | Surface Treatment

陽極處理 Anodizing standard white

特性 | Features

1. 高剛性
2. 扭力大
3. 低慣性
4. 零背隙
5. 適用於工作母機、伺服馬達、
高精密傳動
6. 固定方式: 夾緊式

- High rigid
- High torque
- Low inertia
- Zero backlash
- Suitable for working machine、
servomotor and high precision
transmission mechanism.
- Fixed mode: Clamp type

型號表示 | Product NO

SGH-50C- ϕ 15x ϕ 15

型號 / Type 孔徑 / Inside dia

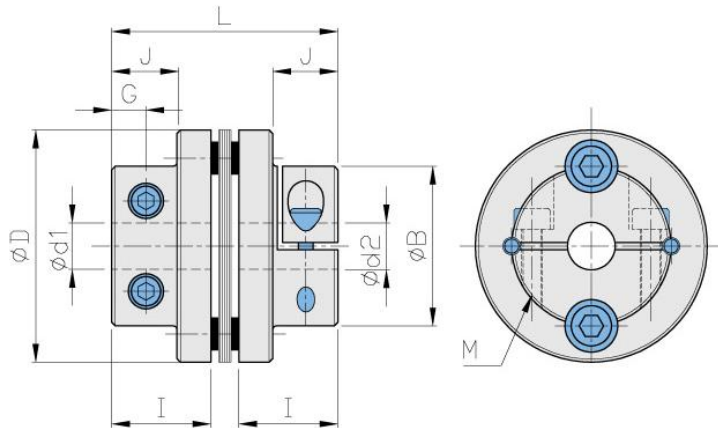

尺寸 | Dimension

單位 / Unit:mm

Catalog Number 型號	D	B	J	I	L	G	M	d1xd2 標準孔徑 (H7)		Mass** 重量 (g)
								Min	Max	
SGH-40C	40	28	10.5	15	34.5	4.75	2-M4	8	16	63
SGH-45C	45	33	10.5	15	34.5	4.75	4-M4	10	18	88
SGH-50C	50	40	15	20	46.5	7	4-M5	12	20	120
SGH-57C	57	42	14	20	47	6	4-M5	10	22	175
SGH-65C	65	50	18	24	55	8	4-M6	15	25	200

性能 | Specifications

單位 / Unit:mm

Catalog Number 型號	Rated Torque 一般扭力 (N.m)	Max. Torque 最大扭力 (N.m)	Max Rotational Frequency 最高回轉速 (Rpm/min)	Moment* of Inertia 慣性 (Kg · m ²)	Errors of Shaft End-Play 容許軸向位差 (mm)	Errors of Angularity 容許偏角 (°)
SGH-40C	6	12	10000	9.2x10 ⁻⁶	±0.02	1.0
SGH-45C	9	18	10000	23.2x10 ⁻⁶	±0.02	1.0
SGH-50C	17	34	10000	32.6x10 ⁻⁶	±0.02	1.0
SGH-57C	25	50	10000	51.2x10 ⁻⁶	±0.02	1.0
SGH-65C	55	110	10000	127.4x10 ⁻⁶	±0.02	1.0

SGS-C 鋼片型 / 夾緊式 / 短型撓性聯軸器

DISK / CLAMP TYPE / SHORTER OF FLEXIBLE COUPLING



材質 | Material

鋁合金 Aluminum alloy
緩衝材: 不銹鋼彈片
Buffer material: SUS disk

表面處理 | Surface Treatment

陽極處理 Anodizing standard white

特性 | Features

- | | |
|---|---|
| <ul style="list-style-type: none"> 1. 高剛性 2. 扭力大 3. 低慣性 4. 零背隙 5. 適用於工作母機、伺服馬達、高精密傳動 6. 固定方式: 夾緊式 | <ul style="list-style-type: none"> • High rigid • High torque • Low inertia • Zero backlash • Suitable for working machine、servomotor and high precision transmission mechanism. • Fixed mode: Clamp type |
|---|---|

型號表示 | Product NO

SGS-27C- $\phi 6 \times \phi 6$
 型號 / Type 孔徑 / Inside dia

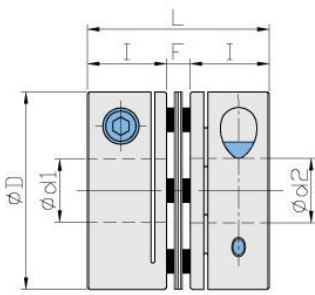

外徑 $\phi 27 \sim \phi 34$

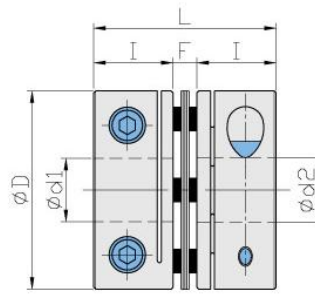
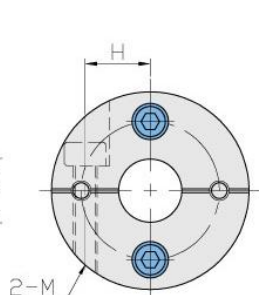

外徑 $\phi 40 \sim \phi 65$

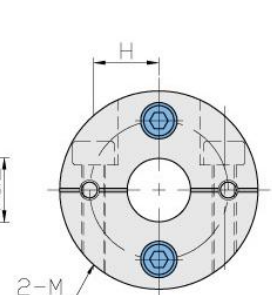

尺寸 | Dimension

單位 / Unit:mm

Catalog Number 型號	D	I	F	L	H	M	d1xd2 標準孔徑 (H7)		Mass** 重量 (g)
							Min	Max	
SGS-27C	27	10.5	2.5	23.5	9.0	M3	5	10	30
SGS-34C	34	12.0	3.0	27.0	12.0	M3	6	14	48
SGS-40C	40	15.0	4.5	34.5	14.0	M4	8	16	93
SGS-45C	45	15.0	5.0	34.5	16.0	M4	10	19	110
SGS-50C	50	20.0	6.0	46.0	18.0	M5	10	22	215
SGS-57C	57	20.0	6.0	46.0	21.0	M5	12	25	240
SGS-65C	65	24.0	7.0	55.0	25.0	M6	12	28	445

性能 | Specifications

單位 / Unit:mm

Catalog Number 型號	Rated Torque 一般扭力 (N.m)	Max. Torque 最大扭力 (N.m)	Max Rotational Frequency 最高回轉速 (Rpm/min)	Moment* of Inertia 慣性 (Kg · m ²)	Errors of Eccentricity 容許偏心 (mm)	Errors of Shaft End-Play 容許軸向位差 (mm)	Errors of Angularity 容許偏角 (°)
SGS-27C	1.5	3	10000	2.5x10 ⁻⁶	0.02	± 0.15	1.0
SGS-34C	6	12	10000	8.2x10 ⁻⁶	0.02	± 0.20	1.0
SGS-40C	7	14	10000	19.0x10 ⁻⁶	0.02	± 0.25	1.0
SGS-45C	10	20	10000	29.7x10 ⁻⁶	0.02	± 0.30	1.0
SGS-50C	17	34	10000	75.0x10 ⁻⁶	0.02	± 0.30	1.0
SGS-57C	25	50	10000	100.0x10 ⁻⁶	0.02	± 0.40	1.0
SGS-65C	25	110	10000	250.0x10 ⁻⁶	0.02	± 0.40	1.0

SGL-C 鋼片型 / 夾緊式 / 撓性聯軸器

DISK / CLAMP TYPE / FLEXIBLE COUPLING



材質 | Material

鋁合金 Aluminum alloy
緩衝材: 不銹鋼彈片
Buffer material: SUS disk

表面處理 | Surface Treatment

陽極處理 Anodizing standard white

特性 | Features

- | | |
|---|---|
| <ol style="list-style-type: none"> 1. 扭力大 2. 偏角誤差較佳 3. 低慣性 4. 零背隙 5. 適用於工作母機、伺服馬達、
高精密傳動 6. 固定方式: 夾緊式 | <ul style="list-style-type: none"> • High torque • High deflection • Low inertia • Zero backlash • Suitable for working machine、
servomotor and high precision
transmission mechanism. • Fixed mode: Clamp type |
|---|---|

型號表示 | Product NO

SGL-40C- $\phi 8 \times \phi 8$

型號 / Type 孔徑 / Inside dia

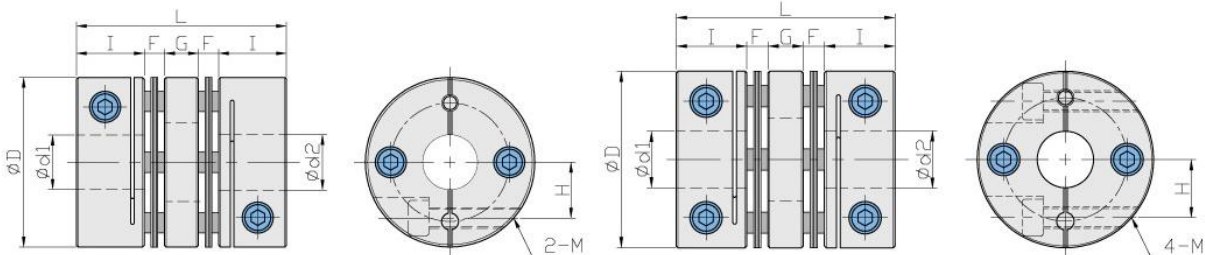

外徑 $\phi 27 \sim \phi 34$

外徑 $\phi 40 \sim \phi 65$

尺寸 | Dimension

單位 / Unit: mm

Catalog Number 型號	D	I	F	G	L	H	M	d1xd2 標準孔徑 (H7)		Mass** 重量 (g)
								Min	Max	
SGL-27C	27	10.5	2.5	6	32	9.0	2-M3	5	10	39
SGL-34C	34	12.0	3.0	7.5	37.5	12.0	2-M3	6	14	70
SGL-40C	40	15.0	4.5	9	48	13.5	4-M4	8	16	128
SGL-45C	45	15.0	4.5	9	48	16.0	4-M4	10	19	140
SGL-50C	50	20.0	6.0	11	63	18.0	4-M5	10	22	285
SGL-57C	57	20.0	6.0	11	63	21.0	4-M5	12	25	310
SGL-65C	65	24.0	7.0	14	76	23.0	4-M6	12	28	570

性能 | Specifications

單位 / Unit: mm

Catalog Number 型號	Rated Torque 一般扭力 (N.m)	Max. Torque 最大扭力 (N.m)	Max Rotational Frequency 最高回轉速 (Rpm/min)	Moment* of Inertia 慣性 (Kg · m ²)	Errors of Eccentricity 容許偏心 (mm)	Errors of Shaft End-Play 容許軸向位差 (mm)	Errors of Angularity 容許偏角 (°)
SGL-27C	1.5	3	10000	3.0x10 ⁻⁶	0.15	± 0.33	1.5
SGL-34C	3	6	10000	10.5x10 ⁻⁶	0.17	± 0.4	1.5
SGL-40C	7	14	10000	26.4x10 ⁻⁶	0.23	± 0.5	1.5
SGL-45C	10	20	10000	41.7x10 ⁻⁶	0.23	± 0.6	1.5
SGL-50C	17	34	10000	135.0x10 ⁻⁶	0.23	± 0.8	1.5
SGL-57C	25	50	10000	144.0x10 ⁻⁶	0.23	± 0.8	1.5
SGL-65C	55	110	10000	360.0x10 ⁻⁶	0.28	± 0.9	1.5

SGB-C 鋼片型 / 夾緊式 / 短型撓性聯軸器

DISK / CLAMP TYPE / SHORTER OF FLEXIBLE COUPLING



材質 | Material

鋁合金 Aluminum alloy
緩衝材: 不銹鋼彈片
Buffer material: SUS disk

表面處理 | Surface Treatment

陽極處理 Anodizing standard white

特性 | Features

1. 高剛性
2. 扭力大
3. 低慣性
4. 零背隙
5. 適用於工作母機、伺服馬達、
高精度傳動
6. 固定方式: 夾緊式

型號表示 | Product NO

SGB-50C- ϕ 20x ϕ 20

型號 / Type 孔徑 / Inside dia

- High rigid
- High torque
- Low inertia
- Zero backlash
- Suitable for working machine、
servomotor and high precision
transmission mechanism.
- Fixed mode: Clamp type

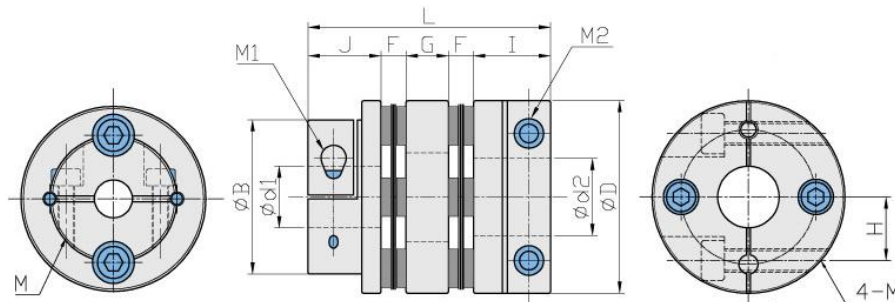

尺寸 | Dimension

單位 / Unit:mm

Catalog Number 型號	D	B	I	F	L	M	d1xd2 標準孔徑 (H7)		Mass** 重量 (g)
							Min	Max	
SGB-40C	40	28	15	4.5	34.5	3-M4	8	16	88
SGB-45C	45	33	15	4.5	34.5	3-M4	8	18	100
SGB-50C	50	40	20	6.0	46	4-M5	10	20	188
SGB-57C	57	42	20	6.0	46	4-M5	12	25	205
SGB-65C	65	50	24	7.0	55	4-M6	12	28	368

性能 | Specifications

單位 / Unit:mm

Catalog Number 型號	Rated Torque 一般扭力 (N.m)	Max. Torque 最大扭力 (N.m)	Max Rotational Frequency 最高回轉速 (Rpm/min)	Moment* of Inertia 慣性 (Kg · m ²)	Errors of Eccentricity 容許偏心 (mm)	Errors of Shaft End-Play 容許軸向位差 (mm)	Errors of Angularity 容許偏角 (°)
SGB-40C	6	12	10000	17x10 ⁻⁶	0.02	± 0.25	1.0
SGB-45C	9	18	10000	23x10 ⁻⁶	0.02	± 0.30	1.0
SGB-50C	17	34	10000	48x10 ⁻⁶	0.02	± 0.30	1.0
SGB-57C	25	50	10000	76x10 ⁻⁶	0.02	± 0.40	1.0
SGB-65C	55	110	10000	185x10 ⁻⁶	0.02	± 0.40	1.0

SGM-C 鋼片型 / 夾緊式 / 撓性聯軸器

DISK / CLAMP TYPE / FLEXIBLE COUPLING



材質 | Material

鋁合金 Aluminum alloy
緩衝材: 不銹鋼彈片
Buffer material: SUS disk

表面處理 | Surface Treatment

陽極處理 Anodizing standard white

特性 | Features

1. 扭力大
2. 偏角誤差較佳
3. 低慣性
4. 零背隙
5. 適用於工作母機、伺服馬達、
高精密傳動
6. 固定方式: 夾緊式

- High torque
- High deflection
- Low inertia
- Zero backlash
- Suitable for working machine、
servomotor and high precision
transmission mechanism.
- Fixed mode: Clamp type

型號表示 | Product NO

SGM-50C- ϕ 20x ϕ 20

型號 / Type 孔徑 / Inside dia

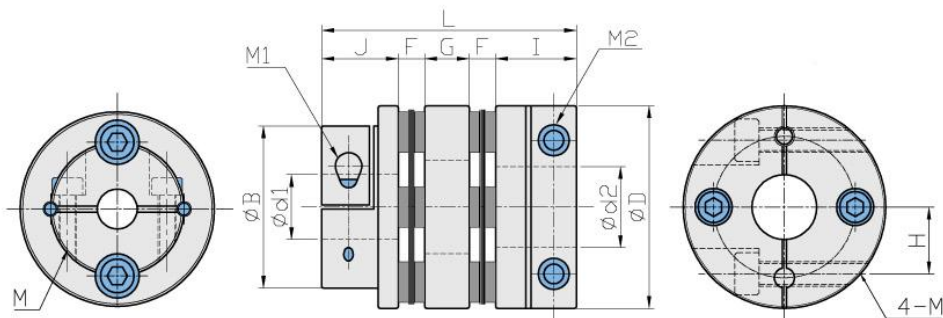

尺寸 | Dimension

單位 / Unit:mm

Catalog Number 型號	D	B	J	F	G	I	L	M1	M2	d1xd2 標準孔徑 (H7)		Mass** 重量 (g)
										Min	Max	
SGM-40C	40	28	15	4.5	9	15	48	1-M4	2-M4	8	16	121
SGM-45C	45	33	15	4.5	9	15	48	2-M4	2-M4	8	18	130
SGM-50C	50	40	20	6	11	20	63	2-M5	2-M5	10	20	250
SGM-57C	57	42	20	6	11	20	63	2-M5	2-M5	12	25	270
SGM-65C	65	50	24	7	14	24	76	2-M6	2-M6	12	28	550

性能 | Specifications

單位 / Unit:mm

Catalog Number 型號	Rated Torque 一般扭力 (N.m)	Max. Torque 最大扭力 (N.m)	Max Rotational Frequency 最高回轉速 (Rpm/min)	Moment* of Inertia 慣性 (Kg · m ²)	Errors of Eccentricity 容許偏心 (mm)	Errors of Shaft End-Play 容許軸向位差 (mm)	Errors of Angularity 容許偏角 (°)
SGM-40C	6	12	10000	20.5x10 ⁻⁶	0.2	±0.6	1.5
SGM-45C	9	18	10000	35.1x10 ⁻⁶	0.2	±0.6	1.5
SGM-50C	17	34	10000	73.3x10 ⁻⁶	0.2	±0.8	1.5
SGM-57C	25	50	10000	112.3x10 ⁻⁶	0.25	±0.8	1.5
SGM-65C	55	110	10000	286.1x10 ⁻⁶	0.3	±0.9	1.5

SGW-C 鋼片型 / 夾緊式 / 撓性聯軸器

DISK / CLAMP TYPE / FLEXIBLE COUPLING



材質 | Material

鋁合金 Aluminum alloy
緩衝材: 不銹鋼彈片
Buffer material: SUS disk

表面處理 | Surface Treatment

陽極處理 Anodizing standard white

特性 | Features

1. 扭力大
2. 偏角誤差較佳
3. 低慣性
4. 零背隙
5. 適用於工作母機、伺服馬達、高精密傳動
6. 固定方式: 夾緊式

型號表示 | Product NO

SGW-50C- ϕ 20x ϕ 20

型號 / Type

孔徑 / Inside dia

- High torque
- High deflection
- Low inertia
- Zero backlash
- Suitable for working machine, servomotor and high precision transmission mechanism.
- Fixed mode: Clamp type

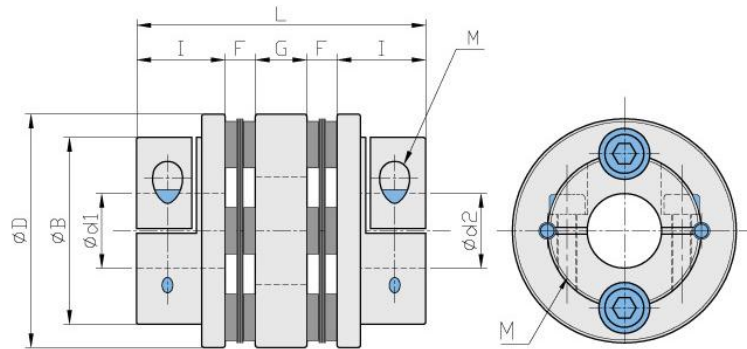

尺寸 | Dimension

單位 / Unit: mm

Catalog Number 型號	D	B	I	F	G	L	M	d1xd2 標準孔徑 (H7)		Mass** 重量 (g)
								Min	Max	
SGW-40C	40	28	15	4.5	9	48	3-M4	8	16	100
SGW-45C	45	33	15	4.5	9	48	4-M4	10	18	120
SGW-50C	50	40	20	6.5	11	64	4-M5	10	20	230
SGW-57C	57	42	20	6.5	11	64	4-M5	10	22	248
SGW-65C	65	50	24	7.0	14	76	4-M6	12	28	540

性能 | Specifications

單位 / Unit: mm

Catalog Number 型號	Rated Torque 一般扭力 (N.m)	Max. Torque 最大扭力 (N.m)	Max Rotational Frequency 最高回轉速 (Rpm/min)	Moment* of inertia 慣性 (Kg · m ²)	Errors of Eccentricity 容許偏心 (mm)	Errors of Shaft End-Play 容許軸向位差 (mm)	Errors of Angularity 容許偏角 (°)
SGW-40C	6	12	10000	15.3x10 ⁻⁶	0.2	±0.6	1.5
SGW-45C	9	18	10000	28.2x10 ⁻⁶	0.2	±0.6	1.5
SGW-50C	17	34	10000	53.6x10 ⁻⁶	0.2	±0.8	1.5
SGW-57C	25	50	10000	87.1x10 ⁻⁶	0.25	±0.8	1.5
SGW-65C	55	110	10000	225.9x10 ⁻⁶	0.3	±0.9	1.5

SAP 止付螺絲固定式 / 剛片式撓性聯軸器

SET / SCREW TYPE / DISK FLEXIBLE COUPLING



材質 | Material

鋼 S45C
緩衝材:不銹鋼彈片
Buffer material : SUS disk

表面處理 | Surface Treatment

染黑 Dye black

特性 | Features

1. 高扭力、高剛性
2. 低慣性、零背隙
3. 適合用於中大型伺服馬達
4. 固定方式:止付螺絲固定式
5. 一般皆含鍵槽加工使之固定

型號表示 | Product NO

SAP-82- \varnothing 20x \varnothing 20

型號/Type 孔徑/Inside dia

- High torque - high rigid.
- Low inertia - zero backlash
- Applicable to large and medium servo motors
- Fixed mode: Set screw type
- Containing keyway processing for fixing

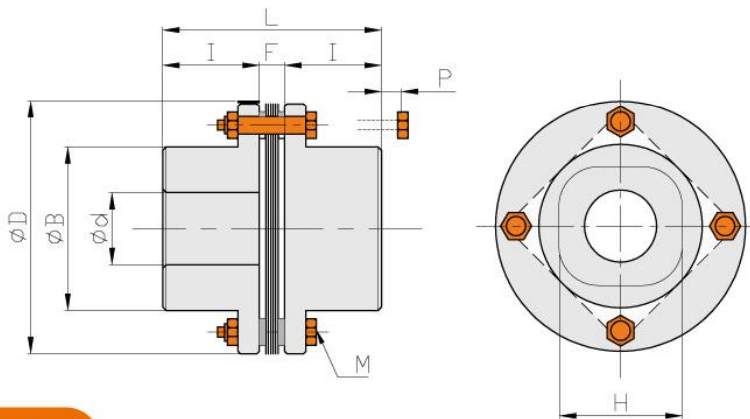

尺寸 | Dimension

單位 / Unit:mm

Catalog Number 型號	D	B	d		L	I	F	H	M	P
			Min	Max						
SAP-68	68	40	10	25	56	25	6	28	4-M6	13
SAP-82	82	54	12	35	56.2	25	6.2	34	4-M6	13
SAP-94	94	58	12	38	69.6	30	9.6	40	4-M8	23
SAP-104	104	68	20	45	76	33	10	42	4-M8	20
SAP-126	126	78	20	50	91	40	11	50	4-M10	25
SAP-144	144	88	20	60	102	45	12	57	4-M10	20
SAP-168	168	104	30	70	164	75	14	108	6-M10	
SAP-180	180	120	30	85	176	80	16	115	6-M10	
SAP-215	215	128	40	90	200	90	20	128	6-M16	

性能 | Specifications

單位 / Unit:mm

Catalog Number 型號	Rated Torque 一般扭力 (N.m)	Max. Torque 最大扭力 (N.m)	Max Rotational Frequency 最高回轉速 (Rpm/min)	Moment* of Inertia 慣性 (Kg · m ²)	Errors of Shaft End-Play 容許軸向位差 (mm)	Errors of Angularity 容許偏角 (°)
SAP-68	40	80	20000	3	±0.8	1
SAP-82	80	160	17000	8.7	±1.0	1
SAP-94	180	360	15000	16	±1.2	1
SAP-104	245	490	13000	26	±1.4	1
SAP-126	441	882	11000	65	±1.6	1
SAP-144	780	1560	9000	99	±1.8	1
SAP-168	1170	2340	5100	238	±1.0	1
SAP-180	1960	3920	4800	365	±1.0	1
SAP-215	4903	9806	4300	830	±1.0	1

SAP-C C型襯套迫緊環固定式 / 鋼片式撓性聯軸器

Fixed By Free-button Compression Ring / Disk Flexible Coupling



材質 | Material

鋼 S45C
緩衝材: 不銹鋼彈片
Buffer material: SUS disk

表面處理 | Surface Treatment

染黑 Dye black

特性 | Features

1. 高扭力、高剛性
2. 低慣性、零背隙
3. 適合用於中大型伺服馬達
4. 固定方式: 免鍵軸環固定式

型號表示 | Product NO

SAP-82C- ϕ 20x ϕ 20

型號 / Type 孔徑 / Inside dia

- High torque、high rigid.
- Low inertia、zero backlash
- Applicable to large and medium servo motors
- Fixed mode: Fixed by free-button compression ring

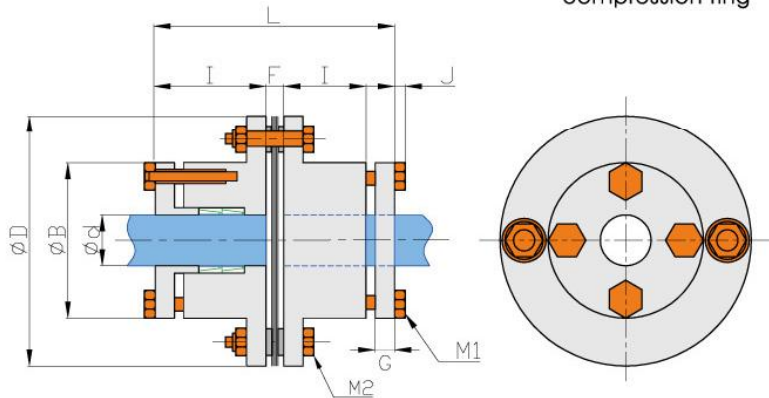

尺寸 | Dimension

單位 / Unit:mm

Catalog Number 型號	D	B	d		L	I	F	G	J	M1	M2
			Min	Max							
SAP-68C	68	40	10	18	76	25	6	7	5	M6x4	M6
SAP-82C	82	54	14	30	76.2	25	6.2	7	5	M6x4	M6
SAP-94C	94	58	14	35	89.6	30	9.6	7	5	M6x4	M8
SAP-104C	104	68	20	42	98	33	10	8	5	M6x6	M8
SAP-126C	126	78	25	50	117	40	11	10	7	M8x4	M10
SAP-144C	144	88	30	55	128	45	12	10	7	M8x4	M10
SAP-168C	168	104	35	65	200	75	14	15	7	M8x6	M10
SAP-180C	180	120	35	75	212	80	16	15	7	M8x6	M10
SAP-215C	215	128	40	85	242	90	20	18	8	M10x6	M16

性能 | Specifications

單位 / Unit:mm

Catalog Number 型號	Rated Torque 一般扭力 (N.m)	Max. Torque 最大扭力 (N.m)	Max Rotational Frequency 最高回轉速 (Rpm/min)	Moment* of Inertia 慣性 (Kg · m ²)	Errors of Shaft End-Play 容許軸向位差 (mm)	Errors of Angularity 容許偏角 (°)
SAP-68C	39	78	20000	3.0	±0.8	1
SAP-82C	78	156	17000	8.7	±1.0	1
SAP-94C	176	352	15000	16	±1.2	1
SAP-104C	245	490	13000	26	±1.4	1
SAP-126C	440	880	11000	65	±1.6	1
SAP-144C	780	1560	9000	99	±1.8	1
SAP-168C	1170	2340	5100	238	±1.0	1
SAP-180C	1960	3920	4800	365	±1.0	1
SAP-215C	4900	9800	4300	830	±1.0	1

標準孔徑鍵槽加工規格

STANDARD APERTURE KEYWAY PROCESSING SPECIFICATIONS



型號表示 | Product NO

SCT-50 - $\varnothing 14$ K6 x 2.3
 $\varnothing 20$ K6 x 2.3

型號 / Type 孔徑 / Inside dia

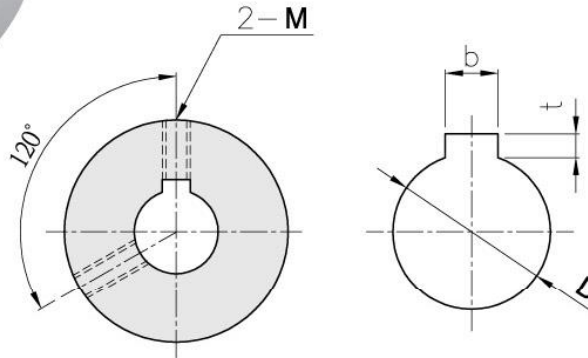

尺寸 | Dimension

單位 / Unit:mm

Stock Bores 標準孔徑 D	鍵槽 Keyways				鍵 尺寸 b x h
	b		t		
	基準 寸法	容許差 (Js9)	基準 寸法	容許差	
10	3	±0.015	1.5	+0.1 0	3 x 3
12	4	±0.015	1.8	+0.1 0	4 x 4
14~18	5	±0.015	2.3	+0.1 0	5 x 5
19~22	6	±0.015	2.8	+0.1 0	6 x 6
24~30	8	±0.030	3.3	+0.2 0	8 x 7
30~38	10	±0.030	3.3	+0.2 0	10 x 8
38~44	12	±0.030	3.3	+0.2 0	12 x 8
44~50	14	±0.043	3.8	+0.3 0	14 x 9
50~58	16	±0.043	4.3	+0.3 0	16 x 10
58~65	18	±0.043	4.4	+0.3 0	18 x 11

扭力換算表 | Torque conversion form

單位	英制 English Unit		國際標準公制 International System of Units	
	Kgf-cm	Kgf-m	N.cm	N.m
Kgf-cm	1	0.01	9.807	0.098
Kgf-m	100	1	980.7	9.807
N.cm	0.102	0.001	1	0.01
N.m	10.2	0.102	100	1

一般馬達規格表 | Motor specification

OUTPUT 輸出		2極 2-Pole				4極 4-Pole					
千瓦 (K.w.)	馬力 (H.p)	軸徑 Shaft Dia (mm)	50Hz		60Hz		軸徑 Shaft Dia (mm)	50Hz		60Hz	
			扭力 Torque (K.g.m)	轉速 Frequency (R.p.m)	扭力 Toqrue (K.g.m)	轉速 Frequency (R.p.m)		扭力 Torque (K.g.m)	轉速 Frequency (R.p.m)	扭力 Torque (K.g.m)	轉速 Frequency (R.p.m)
0.20	0.25	11	0.07	3000	0.06	3600	11	0.13	1500	0.11	1800
0.40	0.50	14	0.13		0.11		14	0.25		0.21	
0.75	1.00	19	0.24		0.20		19	0.49		0.41	
1.50	2.00	24	0.49		0.41		24	0.97		0.81	
2.20	3.00	24	0.71		0.59		24	1.40		1.20	
3.70	5.00	28	1.20		1.00		28	2.40		2.00	
5.50	7.50	38	1.80		1.50		38	3.60		3.00	
7.50	10.00	38	2.40		2.00		38	4.90		4.10	
11.00	15.00	42	3.60		3.00		42	7.10		6.00	
15.00	20.00	42	4.90		4.10		42	9.70		8.10	
18.50	25.00	42	6.00	5.00	42	12.00	10.00				
22.00	30.00	48	7.10	6.00	48	14.30	11.90				
30.00	40.00	55	9.70	8.10	55	19.50	16.20				

孔徑公差表

APERTURE TOLERANCES FORM



單位：μm

尺寸範圍 (mm)	E			F			G			H							Js		J		K		M		N		P		R	
	E7	E8	E9	F6	F7	F8	G6	G7	G8	H5	H6	H7	H8	H9	H10	Js6	Js7	J6	J7	K6	K7	M6	M7	N6	N7	P7	R7	R7		
3 ~ 6	+32	+38	+50	+18	+22	+28	+12	+16	+8	+12	+18	+30	+48	±4	±6	+5	+6	+2	+3	-1	0	-5	-4	-8	-11	-8	-11	-20	-23	
6 ~ 10	+40	+47	+61	+22	+28	+35	+14	+20	+6	+9	+15	+22	+36	+58	±4.5	±7.5	+5	+8	+2	+5	-3	0	-7	-4	-9	-13	-9	-13	-28	
10 ~ 14	+50	+59	+75	+27	+34	+43	+17	+24	+8	+11	+18	+27	+43	+70	±5.5	±9	+6	+10	+2	+5	-4	0	-9	-5	-11	-16	-11	-16	-34	
14 ~ 18	+32	+32	+32	+16	+16	+16	+6	+6	0	0	0	0	0	0	±6.5	±10.5	+8	+12	+2	+6	-4	0	-11	-7	-14	-20	-14	-20	-34	
18 ~ 24	+61	+73	+92	+33	+41	+53	+20	+28	+9	+13	+21	+33	+52	+84	±8	±12.5	+10	+14	+2	+6	-15	-17	-24	-28	-35	-41	-24	-30	-40	
24 ~ 30	+40	+40	+40	+20	+20	+20	+7	+7	0	0	0	0	0	0	±8	±12.5	+10	+14	+3	+7	-4	0	-12	-8	-17	-25	-17	-25	-40	
30 ~ 40	+75	+89	+112	+41	+50	+64	+25	+34	+11	+16	+25	+39	+62	+100	±8	±12.5	+10	+14	+3	+7	-4	0	-12	-8	-17	-25	-17	-25	-40	
40 ~ 50	+50	+50	+50	+25	+25	+25	+9	+9	0	0	0	0	0	0	±8	±12.5	+10	+14	+3	+7	-4	0	-12	-8	-17	-25	-17	-25	-40	
50 ~ 65	+90	+106	+134	+49	+60	+76	+29	+40	+13	+19	+30	+46	+74	+120	±9.5	±15	+13	+18	+4	+9	-5	0	-14	-9	-21	-60	-30	-60	-65	
65 ~ 80	+60	+60	+60	+30	+30	+30	+10	+10	0	0	0	0	0	0	±9.5	±15	+13	+18	+4	+9	-5	0	-14	-9	-21	-60	-30	-60	-65	
80 ~ 100	+107	+126	+159	+58	+71	+90	+34	+47	+15	+22	+35	+54	+87	+140	±11	±17.5	+16	+22	+4	+10	-5	0	-16	-10	-24	-73	-38	-73	-100	
100 ~ 120	+72	+72	+72	+36	+36	+36	+12	+12	0	0	0	0	0	0	±11	±17.5	+16	+22	+4	+10	-5	0	-16	-10	-24	-73	-38	-73	-100	
120 ~ 140																														
140 ~ 160	+125	+148	+185	+68	+83	+106	+39	+54	+18	+25	+40	+63	+100	+160	±12.5	±20	+18	+26	+4	+12	-8	0	-20	-12	-28	-50	-48	-50	-60	
160 ~ 180	+85	+85	+85	+43	+43	+43	+14	+14	0	0	0	0	0	0	±12.5	±20	+18	+26	+4	+12	-8	0	-20	-12	-28	-50	-48	-50	-60	
180 ~ 200																														
200 ~ 225	+146	+172	+225	+79	+96	+122	+44	+61	+20	+29	+46	+72	+115	+185	±14.5	±23	+22	+30	+5	+13	-8	0	-22	-14	-33	-63	-60	-63	-79	
225 ~ 250	+100	+100	+100	+50	+50	+50	+15	+15	0	0	0	0	0	0	±14.5	±23	+22	+30	+5	+13	-8	0	-22	-14	-33	-63	-60	-63	-79	
250 ~ 280	+162	+191	+240	+88	+108	+137	+49	+69	+23	+32	+52	+81	+130	+210	±16	±26	+25	+36	+5	+16	-9	0	-25	-14	-33	-63	-60	-63	-79	
280 ~ 315	+110	+110	+110	+56	+56	+56	+17	+17	0	0	0	0	0	0	±16	±26	+25	+36	+5	+16	-9	0	-25	-14	-33	-63	-60	-63	-79	
315 ~ 355	+182	+214	+265	+98	+119	+151	+54	+75	+25	+36	+57	+89	+140	+230	±18	±28.5	+29	+39	+7	+17	-10	0	-26	-16	-41	-87	-87	-93	-103	
355 ~ 400	+125	+125	+125	+62	+62	+62	+18	+18	0	0	0	0	0	0	±18	±28.5	+29	+39	+7	+17	-10	0	-26	-16	-41	-87	-87	-93	-103	
400 ~ 450	+198	+232	+290	+108	+131	+165	+60	+83	+27	+40	+63	+97	+155	+250	±20	±31.5	+33	+43	+8	+18	-10	0	-27	-17	-45	-103	-103	-108	-166	
450 ~ 500	+135	+135	+135	+68	+68	+68	+20	+20	0	0	0	0	0	0	±20	±31.5	+33	+43	+8	+18	-10	0	-27	-17	-45	-103	-103	-108	-166	